

# BARD5

## 08.5005.18.927.GR

POWER: 18W LED  
VOLTAGE: 220V/240V 50/60Hz

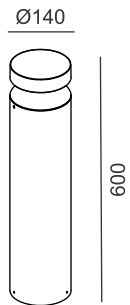

### SAFETY INSTRUCTIONS

- The appliance should be installed, connected and tested by qualified electrician, and in accordance with local regulations.
- Turn off the power supply before installation or maintenance of the appliance, and make sure that the cables will not be squeezed or damaged by sharp edges.
- The appliance should not be covered by insulation blankets or similar materials.
- Clean the appliance with a soft cloth and a standard PH neutral detergent. Stainless steel surfaces should be maintained regularly.
- Misuse of, or changes to the appliance shall nullify the guarantee. The manufacturer is free to change the design, specifications and instructions for assembly.

**⚠ DO NOT CONNECT THE APPLIANCE DIRECTLY TO HIGH-VOLTAGE POWER SUPPLY IF DRIVER IS NOT CONNECTED.**

USE THE CORRECT DRIVER TO CONNECT.

DO NOT TOUCH OR CLEAN THE LED ARRAY!  
IN ORDER TO AVOID DAMAGING THE LED CHIP!

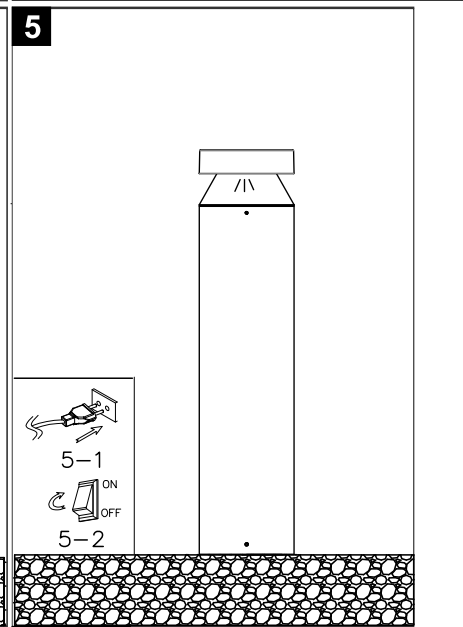
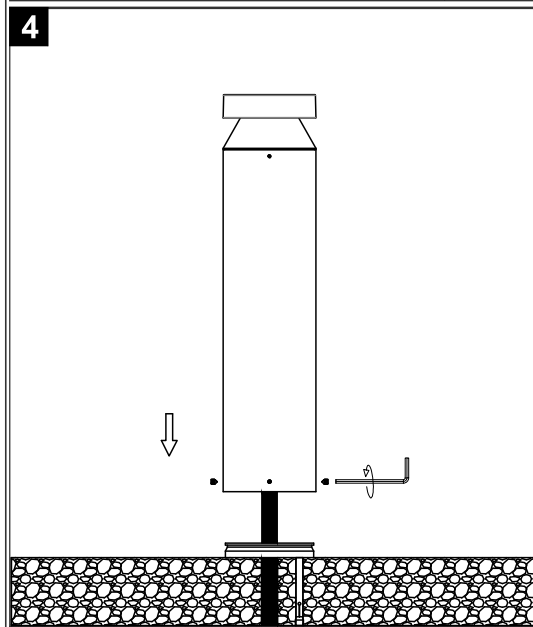
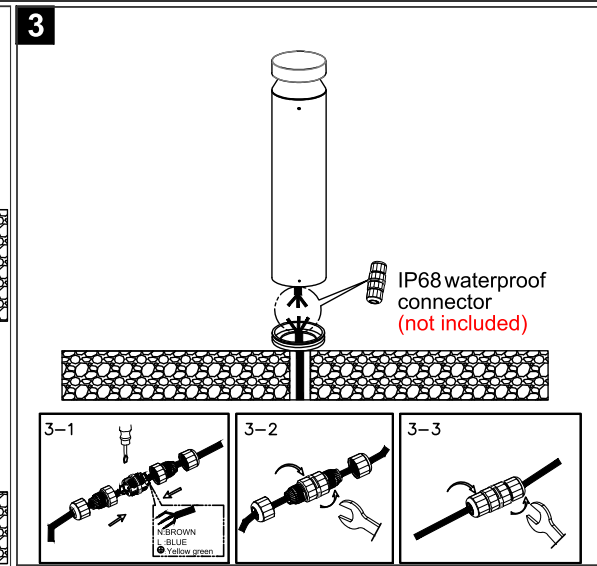
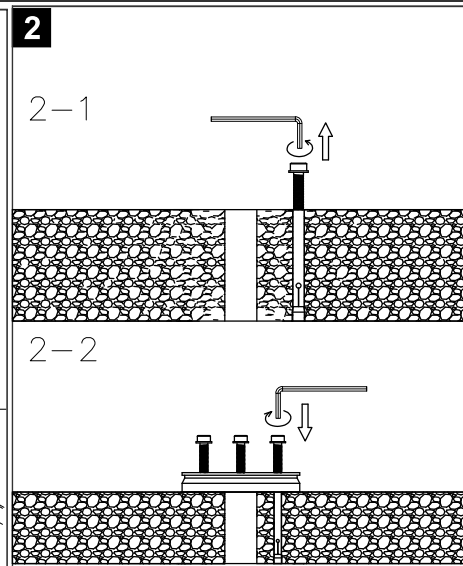
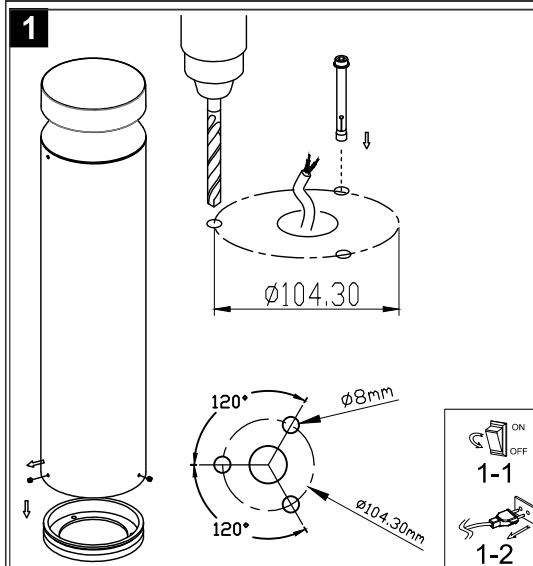
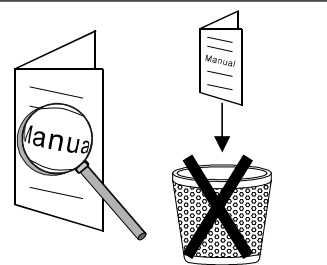
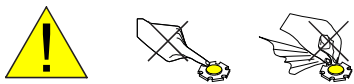

**LTX** Lightonix sp. z o.o.  
UI Hoza, 86 lok. 410  
00-682 Warszawa, Poland  
Telephone: +48 516 808 834  
E-mail: info@ltx-led.com